

EN FR DE SV NO NL ES IT

# OPTIMUS NOVA



OPTIMUS | COOKING SINCE 1899

# OPTIMUS NOVA

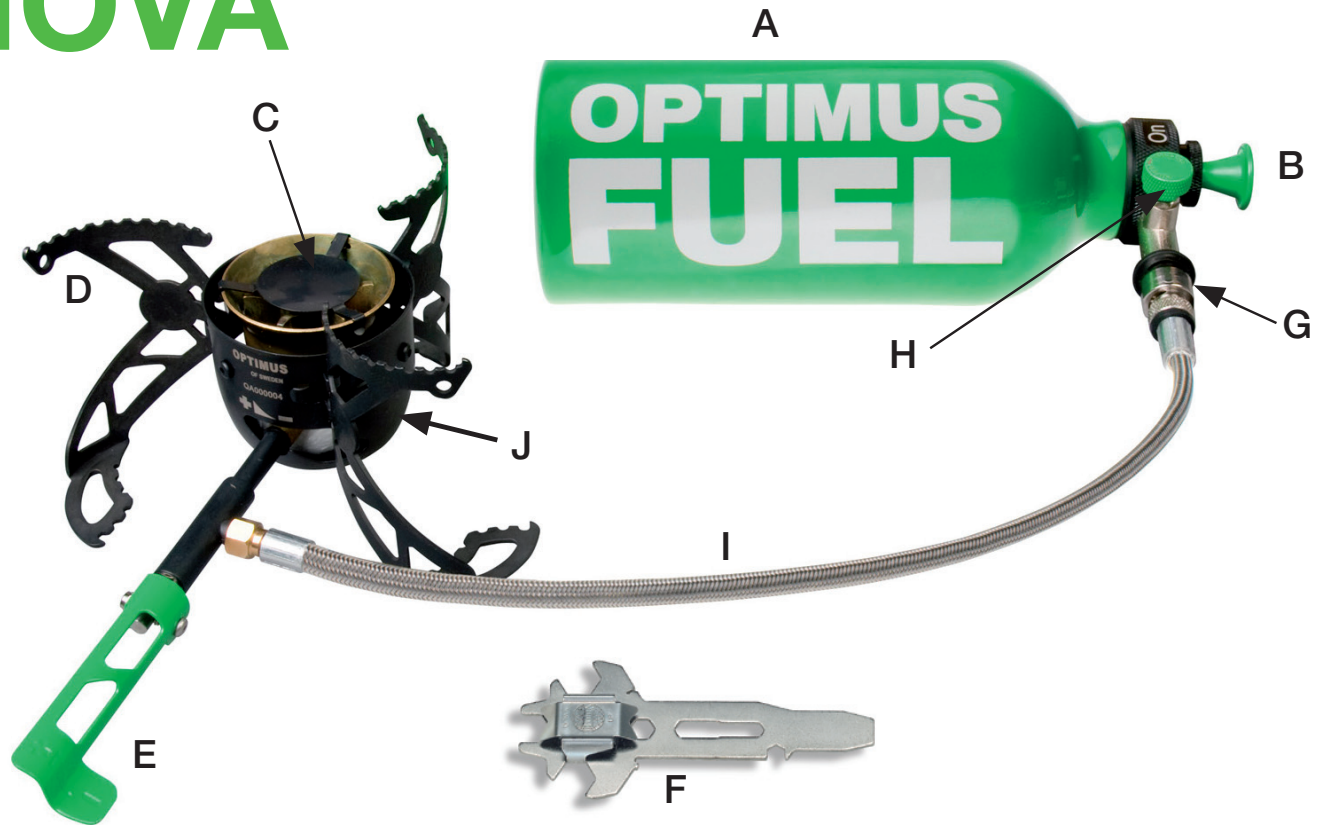

- A Fuel bottle/ Bouteille de fuel/ Brennstoffflasche/ Bränsleflaska/ Brenselflaske/ Brandstoffles/ bombona de combustible/ bombola del combustible
- B Pump/ Pompe/ Pumpe/ Pump/ Pumpe/ Pomp/ Bomba/ Pompa
- C Burner/ Brûleur/ Brenner/ Brännare/ Brenner/ Brander/ Quemador/ Bruciatore
- D Pot support/ Pieds/ Stützbeine/ Ben/ Ben/ Poten/ Soportes/ Piedini di supporto
- E Control valve/ Robinet de réglage d'alimentation/ Brennstoffregler/ Bränslereglage/ Brenselregulator/ Ventiel/ Válvula de control/ Valvola di controllo
- F Multitool/ Outil multi-usages/ Multiwerkzeug/ Multiverktyg/ Multiverktøy/ Multi-sleutel/ Multiherramienta/ Attrezzo multifunzione
- G Quick connect/ Raccord rapide/ Schnellanschluss/ Snabbkoppling/ Hurtigkopling/ Snelkoppeling/ Conector rápido/ Allacciamento rapido
- H Fuel feed valve/ Soupape d'alimentation de combustible/ Ventil für die Brennstoffzufuhr/ Bränsleventil/ Brenselventil/ Ventiel van de brandstof toevoer/ Válvula de alimentación de combustible/ Valvola di alimentazione combustibile
- I Fuel hose/ Tuyau à combustible/ Brennstoffschlauch/ Bränsleslang/ Brenselslange/ Brandstofslang/ Manguera del combustible/ Manichetta del combustibile
- J Cup/ Coupelle/ Behälter/ Kopp/ Kopp/ Behuizing/ Taza/ Tazza

TECHNICAL SPECIFICATION/ FICHE TECHNIQUE /TECHNISCHE DATEN/ TEKNISK SPECIFIKATION/TEKNISKE SPESIFIKASJONER/ TECHNISCHE GEGEVENS/ DATOS TECNICOS/ DATI TECNICI



**Fuel/Combustible/Brennstoff/ Bränsle/Brensel/Brandstof/Combustible/Combustibile:**

Optimus Arctic Fuel, White Gas, Gasoline/petrol, Kerosene, Diesel, Jet Fuel, and others/ Combustible Optimus Arctic, essence purifiée. Essence automobile, pétrole lampant, gazole, kérosène, etc./Optimus Arctic Fuel, weißes Gas, Autobenzin, Kerosin, Diesel, Turbinentreibstoff und andere/ Optimus Arctic Fuel, ren bensin, bilbensin, fotogen, diesel mm./Optimus Arctic Fuel, kjemisk ren bensin, bilbensin, parafin, diesel, jetdrivstoff med mer/Optimus Arctic Fuel, witte benzine, benzine, kerosine, diesel/Optimus Arctic Fuel, gasolina, queroseno, gasóleo, gasolina blanca/Optimus Arctic Fuel, benzina bianca, benzina, kerosene, gasolio



**Burn time/Durée de combustion/ Brenndauer/Brinntid/Brennetid/ Verbrandingsduur/Duración de combustión/Tempo di bruciatura:**

Up to 2 hours at maximum output (using 450 ml fuel)/jusqu'à 2 heures au maximum de puissance (avec 450 ml de combustible)/Bis zu zwei Stunden bei voller Leistung (mit 450 ml Brennstoff)/ Upp till två timmar vid full effekt (med 450 ml bränsle)/Inntil 2 timer med maks. effekt (med 450 ml brensel)/Tot 2 h met maximaal vermogen (met 40 ml grandstof)/a 2 horas a rendimiento máximo (con 450 ml combustible)/ Fino a 2 ore a rendimento massimo (con 450 ml combustibile)



**Boil time (1 L of water)/Durée nécessaire à l'ébullition/Kochzeit/Koktid/ Koketid/Koktid/Tiempo de cocción/ Tempo di cottura:**

As little as 3.5 minutes depending on climate, altitude etc./à partir de 3,5 minutes selon le climat, l'altitude etc. (1 l d'eau)./Bis zu 3,5 Minuten, abhängig von Klima, Höhe etc./Ned till 3,5 minut beroende på klimat, höjd etc./Ned til 3,5 minutter, avhengig av klima, høyde over havet osv./slechts 3.5 min, al naar klimaat, hoogte enz./ Solo 3.5 min según el clima, la altitud etc./Appena 3.5 min a seconda di clima, altitudine etc.



**Weight (without pump)/Poids pompe non comprisee/Gewicht (ohne pumpe)/Vikt (utan pumpe)/Vekt (uten pumpe)/Gewicht (zonder pomp)/ Peso (sin bomba)/Peso (senza pompa):**  
330 grams (11.5 oz)



**Weight (with pump)/ Poids pompe comprisee/ Gewicht (mit pumpe)/ Vikt (med pump) /Vekt (med pumpe)/ Gewicht (met pomp)/Peso (con bomba)/Peso (con pompa):**  
460 grams (16 oz)



**Measurements folded/Dimensions replié/Abmessungen zusammengeklappt /Mått, ihopfälld/Mål slått sammen/Maten gevouwen/Dimensión plegado/Dimensione piegato:**  
90x65x140 mm (3.5x2.5x5,5 inches)



**Rating/Puissance nominale/ Leistung/Effekt /Effekt/Watt/Efecto/ Watt:**  
2850W

**Preheating/Préchauffage/Vorwärmen/Fövärmning/Forvarming/ Voorverwarming/Precalear/Pre-riscaldar:**

30-90s depending on fuel type/ de 30 à 90 secondes selon le combustible./30-90 Sekunden je nach Brennstofftyp/ 30-90s beroende på bränsletyp/30-90 s, avhengig av brenseltype/30-90 s, al naar type het brandstof/30-90 s según tipo del combustible/30-90 s a seconda del tipo di combustibile

## PEACE AND QUIET

Congratulations, you're the proud new owner of one of our most advanced stoves. That must mean you're on your way to exciting, demanding adventures. We know that you've made a smart choice with this stove and when you use it, you'll know too. Get ready for great outdoor cooking, thanks to over a century of success at Optimus.

Being the outdoor enthusiasts we are, we understand that you're probably curious about your new stove and anxious to try it out as soon as possible. But even if you have plenty of experience with similar products, please read the manual so you become familiar with the specifics relating to this stove.

All of us at Optimus hope that you will take the time to sit down and enjoy the peace and quiet unique to food preparation in the Great Outdoors.

Good luck, and bon appétit!



## SAFETY FIRST!

When you use your Optimus Nova, you'll be handling highly flammable fuels. If used incorrectly, you will be putting yourself and everything around you in danger. Make sure that you've understood everything in this manual before using the stove. Try it out and get to know it properly before you head out for adventure.

Check that no fuel is leaking before you light the stove. If you have spilled any fuel, the safest thing is to move the stove. If you discover fuel leaking from any part of the stove, the leak must be taken care of before the stove is used. Never use a stove that is leaking fuel.

The Optimus Nova is designed for outdoor use only. A lit stove consumes oxygen and gives off carbon monoxide. If you use the stove indoors in an unventilated area or in a tent, you run the risk of falling victim to carbon monoxide poisoning.

Make sure that you never hold your face or any other part of your body over the stove. Also make sure you keep your clothes away from the stove. Many materials used for outdoor clothing, sleeping bags, etc. are highly flammable.

Be very careful when lighting a stove that has just been used. A hot burner can vaporize the fuel. The fuel may ignite explosively. Allow the stove to cool properly before lighting it again.

Never leave the stove without supervision. Never leave children unattended near the stove.

Use Optimus Nova only for cooking food and boiling water.

## EN - HOW YOUR STOVE WORKS

The Optimus Nova is a multifuel stove. This means that you can use a number of different liquid fuels, such as gasoline, diesel and kerosene. Unlike propane gas, these are often easy to get hold of even in the most remote corners of the globe. They also make your stove considerably more powerful when used during winter trips.

Preparing food on a multifuel stove using liquid fuel is slightly more complicated than using a gas stove. First off, the fuel has to be pressurized in order to make the stove as hot as possible. The gas in a gas bottle is already pressurized when you buy it from the shop, but the liquid fuel you put in your fuel bottle is not. Therefore, you have to pump up the pressure in the bottle yourself.

You also need to preheat the stove for a short time using a squirt of fuel. Preheating involves heating up the burner to such an extent that the fuel is vaporized when it passes through the burner's nozzle. Vaporized fuel burns efficiently with a blue flame and a hissing sound.

When your food is cooked and you want to shut off the stove, you turn the entire fuel bottle to OFF position. This places the pump in a position whereby air comes out of the bottle instead of fuel. When the fuel remaining in the hose has burned, the flame goes out on its own and the pressure remaining in the bottle seeps out.

If you turn off the stove using the control valve only, fuel will remain in the hose and the bottle will stay pressurized. This will cause a fuel spill when you dismantle the stove or transport it in your pack.

The following pages show you how to use the stove, step-by-step.

### 1 Fill the bottle with fuel and screw on the pump.

Do not fill the fuel bottle to the brim. It should only be filled about  $\frac{3}{4}$  full. You have to leave some space for the pump and the air that will be compressed when you pump up the pressure. To ensure proper usage of the "On / Off" function by turning the bottle, check the fuel intake hose is bent away from the pump cylinder. The brass fuel filter holder should touch the interior wall of the fuel bottle. Check that the seal is positioned correctly in its groove before you turn the pump into position. The seal must be flat and even all round. Screw on the pump properly and wipe off any spilled fuel.

Read more about various fuels in the chapter on fuels.



**WARNING!** Make sure that you stay well away from a lit stove or naked flame when you are filling the bottle with fuel. Use only Optimus fuel bottles.

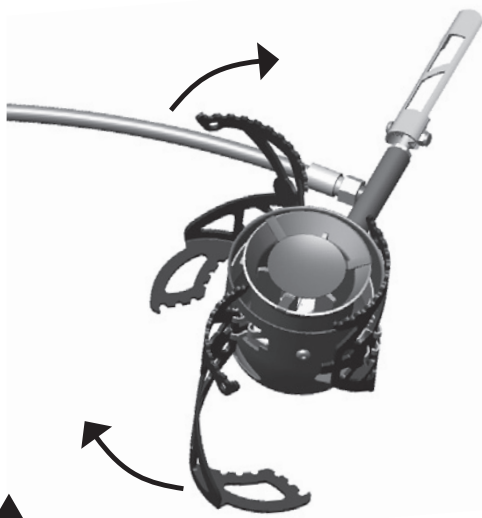

### Fold out the pot supports on the burner. Fold out the fuel control valve and make sure that it's in the off position.

# 2

It gets very hot under the stove, so remember to place the stove on a firm base which cannot catch fire.

Make sure that the control valve is closed before pumping pressure into the bottle.

Do not use pans with a diameter that exceeds 280 mm (11 inches). The weight of the pan plus food should not exceed 4 kg (8.8 lbs.).



**WARNING!** Do not place the stove on or near flammable materials. Avoid exposing the fuel bottle to heat. The bottle may explode if it is exposed to heat. Only use wind screens approved by Optimus for use together with the Optimus Nova. Never cover the fuel bottle with the wind screen. There must always be a clearance of at least 15 cm (6 inches) between the fuel bottle and a pot or pan on the stove to prevent overheating of the fuel bottle.



### Clear the nozzle in the burner.

# 3

All fuels contain contaminants that can block the nozzle in the burner. The Optimus Nova has a built-in cleaning needle that is used to clear the nozzle with ease. Move the multitool a few times directly beneath the burner's base nut. The magnets on this tool force the needle to move, thereby cleaning the nozzle.

Get into the habit of cleaning the stove before you start preparing food. This will reduce the risk of the nozzle in the burner getting blocked. See the section entitled "Cleaning and maintenance" if the stove functions poorly even though it has been cleared using the multitool.



## EN - HOW YOUR STOVE WORKS

### 4 Connect the fuel hose to the pump's quick connect.

Make sure that the fuel feed valve is closed (turned fully clockwise).

Check the o-ring on the tip of the fuel hose. Replace the o-ring if it is damaged, missing or worn.

Fit the fuel hose into the quick connect and make sure the bayonet joint locks.

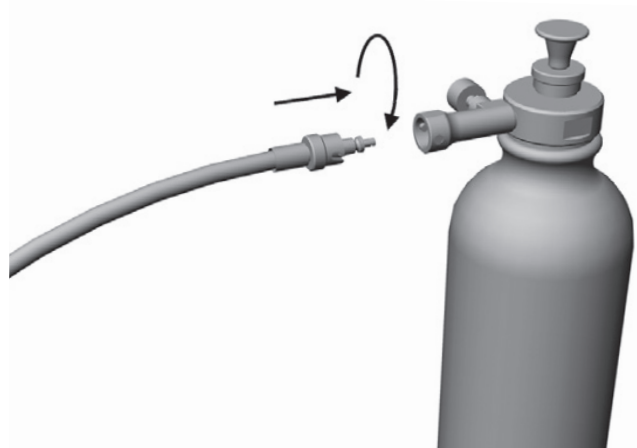

### 5 Pump up pressure in the fuel bottle.

The fuel in the bottle is not pressurized, so you have to pump up pressure before the stove can be lit and used.

The fuel bottle can be placed in two different positions, with the word ON or OFF on the top of the pump. Place the bottle in the ON position when you want to use the stove.

If the fuel bottle is full (3/4 is full), you will need to pump around 25 times. Pump about 40 times if the bottle is half full or less. There must be firm resistance in the pump when you reach the stove's working pressure. Open the fuel feed valve fully.

The air pressure in the fuel bottle is crucial to the heat of the stove. When preparing food, you may have to do some more pumping in order to maintain maximum heat. However, if you pump up too high a pressure the fuel flow will be too great resulting in a yellow flame.

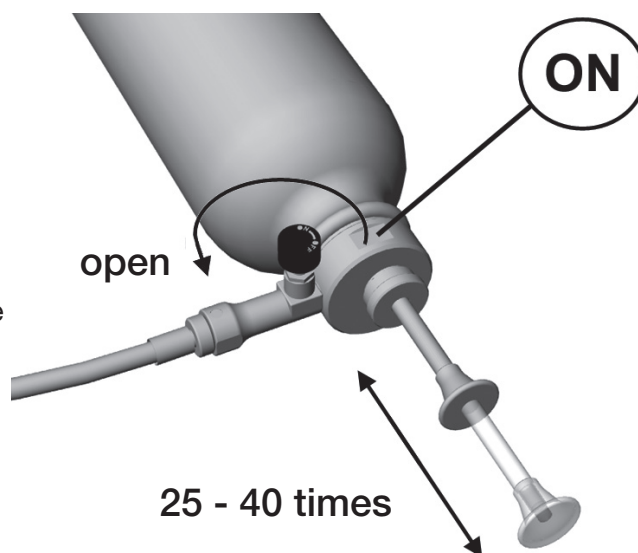

**WARNING!** Make sure that no fuel is leaking out before you light the stove. Never light a stove that is leaking fuel.

## HOW YOUR STOVE WORKS -EN

### Release a small amount of fuel for preheating.

6

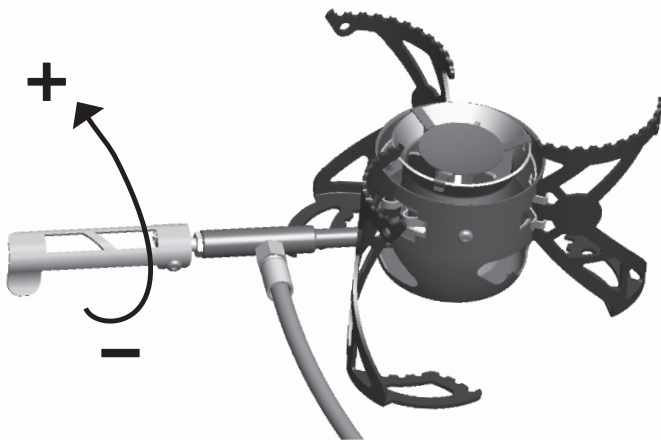

The stove's burner has to be hot to allow the liquid fuel to vaporize at the nozzle and burn efficiently. Therefore, you have to preheat the burner before you can start preparing food. This is done by first releasing a squirt of fuel and allowing it to burn for a short time, heating up the nozzle in the burner.

The preheating time varies depending on what type of fuel you are using. For example, gasoline is vaporized more readily than kerosene and requires less preheating. Preheating takes longer when it is cold and if the stove is not protected from the wind.

Start by opening the control valve for two seconds. It is difficult to see how much fuel has run out onto the wick, but as time goes by you will get a feel for this. Proceed with caution as you familiarize yourself with your stove.



**WARNING!** Check for fuel leaks at the bottle, pump, hose and burner before lighting the stove.

### Light the fuel and wait until the flame has almost burned out.

7

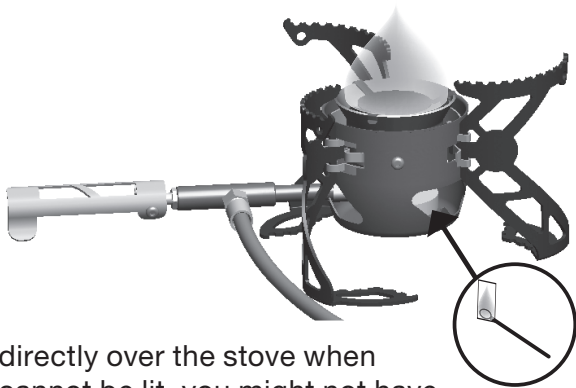

directly over the stove when cannot be lit, you might not have

6. The fuel will burn with a yellow, flaring flame and heat the burner. Wait a short time until the fuel has almost burned out and the flame has become small.

Light the fuel at the wick using a match or lighter. The wick is the white pad in the center of the burner, in the bottom of the cup. This is accessed via one of the holes in the cup. Of course, it is important to make sure that you never hold your face or any other part of your body you light it. The fuel may ignite explosively. If the stove released enough fuel. If this is the case, repeat step



**WARNING!** Keep children away from the stove and never leave it without supervision.



## EN - HOW YOUR STOVE WORKS

### 8 Open the control valve again and adjust the flame until it turns blue and there is a hissing sound.

Once the preheating flames are almost out, open the control valve again by about a quarter turn. If the burner is hot enough, the fuel will vaporize and be ignited by the preheating flame. The flame should then turn bluish and hiss gently after a short time. If the vaporized fuel does not ignite, light it carefully with a match.

A yellow, flaring flame means that the burner is not hot enough or that you have opened the control valve too far. Start off by closing the control a little. If the flame does not turn blue after 10-15 seconds, the burner is not hot enough and you have to preheat the stove for a little longer. In this case, close the control valve one more time, wait until the flames are almost out and then open the control valve again.

When the stove is burning as it should, you can gradually open the control valve and make it hotter. Maximum heat is attained when the control valve has been opened by about two turns. If you open it by more than two turns, you will use up more fuel without making the stove any hotter. If the flame flares up and turns yellow, turn down the control slightly and wait until the flame has turned blue again.

The burner is designed to burn best and give maximum heat with a pan in place.

Once the stove has been burning for a while, it may be a good idea to pump a couple of times in order to maintain pressure in the bottle. Too little pressure in the bottle will result in poor performance. Too much pressure will also lead to poor performance and a yellow, flaring flame. With a little practice, you will learn how often and how much to pump in order to maintain an effective flame.

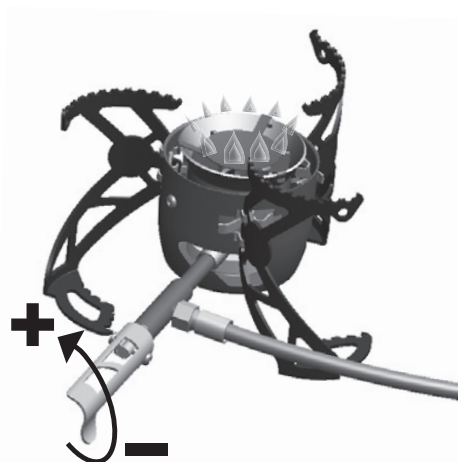

**WARNING!** Never move a hot stove or a stove that is in use.

### 9 Shut off the stove by turning the bottle to OFF position.

If you want to avoid annoying fuel spills when you dismantle and transport the stove, shut it off by turning the fuel bottle to OFF position. OFF will then be visible from above on the pump. The fuel in the hose will now burn up and the remaining pressure in the

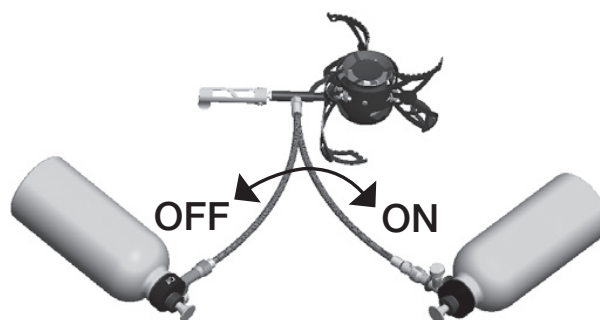

## HOW YOUR STOVE WORKS - EN

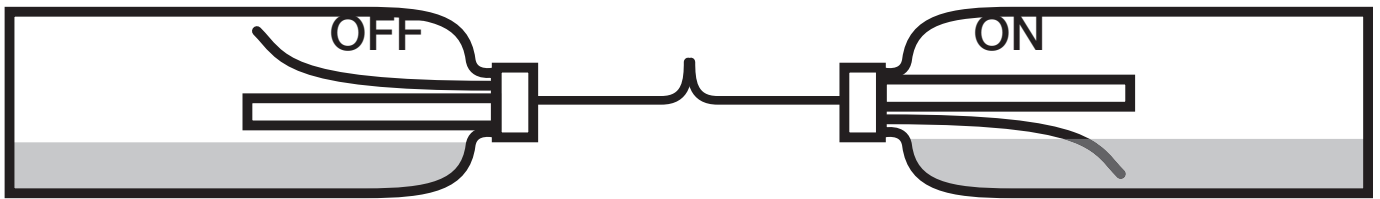

bottle will seep out. The flame will not go out immediately, but will burn for a few minutes depending on which fuel you are using and how open the control valve is.

To release the pressure in the fuel bottle faster, you can let the stove burn at full throttle. It will take about 30-40 seconds for the flame to extinguish, and another 30 seconds for the remaining air to seep out.

If you have shut down the stove by closing the control valve only, you will have to release the pressure in the bottle by way of the pump. This entails a great risk that fuel will spill on you and your equipment.

If the stove is to be used again without being moved, you can switch off the stove using the control valve. Allow the stove to cool properly before lighting it again.

**IMPORTANT:** To prevent fuel leakage, always turn off the fuel valve (by turning it clockwise) when the stove is not in use.



**WARNING!** Be very careful when lighting a stove that has just been used. A hot burner can vaporize the fuel. Vaporized fuel is very difficult to see. There is a risk that the fuel will ignite explosively and you get burned.

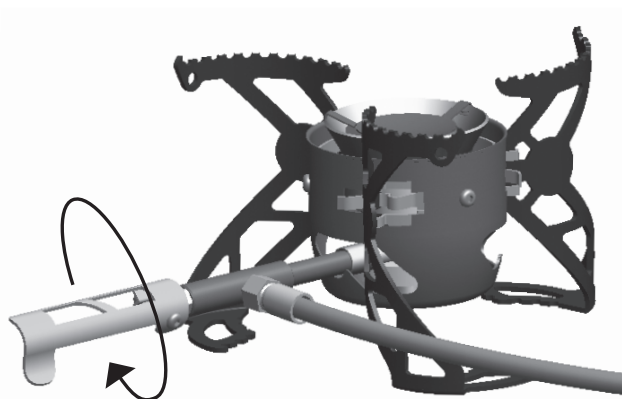

Let the stove **10**  
cool down.

Allow the stove to cool properly before packing it.

We recommend that you leave the control valve open when you have shut off the stove by turning the bottle to the OFF position. If you close the valve too tight when the stove is hot, it may be hard to open the next time you use the stove.

## EN - HOW YOUR STOVE WORKS / FUELS

### 11 Remove the fuel hose.

Close the fuel feed valve fully. Remove the fuel hose by releasing the bayonet joint and then pull the hose out of the quick connect. Sometimes there may be a little pressure remaining in the bottle which seeps out when you disconnect the quick connect. The same is true when you unscrew the pump from the bottle. Turn your face away from the stove to protect your eyes when separating the quick connect.

Be sure to apply the covers on the tip of the fuel hose and the quick coupling so dirt will not enter.

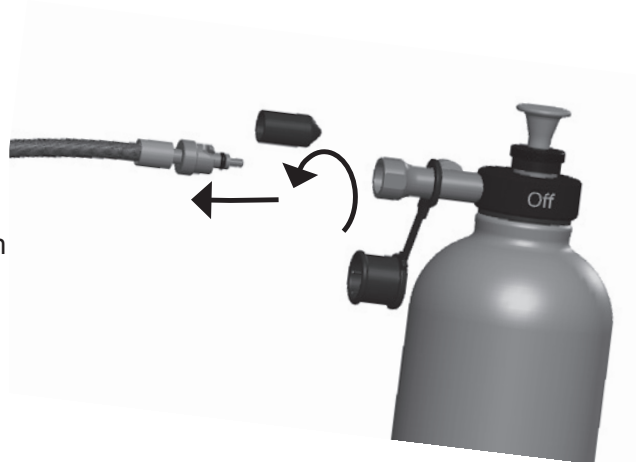

**WARNING! Never disconnect the hose immediately after switching off the stove. Fuel may splash on the hot burner and ignite.**

## FUELS

The Optimus Nova has a burner designed to use petroleum-based fuels. Therefore, you cannot use alcohol-based fuel. We recommend that you use chemically pure gasoline (not automotive gasoline) or high-quality kerosene. Under no circumstances should you handle fuel near a lit stove or in your tent.

Use a funnel with a filter when filling the bottle so as to avoid dirt and foreign bodies getting into the fuel. Never mix different kinds of fuel. Empty the bottle entirely before putting in a different fuel.

### GASOLINE

It is often very easy to get hold of gasoline, even though the quality is variable. Chemically pure gasoline is preferable. Ordinary automotive gasoline contains additives which will contaminate your stove and are hazardous for your health. If you have to use automotive gasoline, use unleaded gasoline wherever possible. Gasoline is highly flammable and preheating occurs quickly. However, gasoline is also very volatile and burns explosively.

### KEROSENE

Kerosene has more or less the same energy value as gasoline but is considerably less of a hazard in terms of fire. It is used all over the world and is easy to get hold of. You can often find kerosene in

places where you would not find other fuels, such as in food stores. Preheating takes slightly longer with kerosene than with gasoline and is slightly sooty, but there is not much of a risk of explosion. Kerosene also requires you to clean the burner more often.

We recommend the use of kerosene, as it is primarily designed for use in stoves and heaters. We do NOT advise the use of lamp oil or fire lighting fluid (charcoal lighter).

NOTE: In harsh cold, there is a risk of kerosene solidifying, which makes the stove unusable.

### **DIESEL**

Diesel is somewhat similar to kerosene, but preheating takes slightly longer and it produces even more soot. We recommend that you only use diesel as last option. If you do so, use diesel for cars. Avoid marine diesel entirely. One positive aspect of diesel is that it can be found all over the world.

### **FUEL CONSUMPTION**

Expect to use 0.10-0.15 liters (3.3 – 5 fl. oz.) of fuel per person per day. In the winter, you will use more fuel for melting snow, preheating for longer, etc. In this instance, expect to use twice as much fuel. To keep your fuel consumption down, it is important to adjust the flame so that the stove burns as efficiently as possible. This does not mean opening the control valve as much as possible; quite the opposite, in fact. If you do that, you will use up more fuel but your food will not cook any faster. To heat your food as quickly as possible, it is also a good idea to always use a lid on your pan and make sure that the pan is protected from the wind. Use the wind screen that comes with your stove. This will also reflect heat back at your pan.

Visit [www.optimusstoves.com](http://www.optimusstoves.com) for more information about fuels.

## EN - TIP!

### **CHOOSING A FUEL**

Liquid fuels work considerably more effectively than gas in cold conditions. The pressure in gas tubes is impaired at just a few degrees below freezing. Keep in mind that some poor qualities of kerosene and diesel will solidify in the cold. If you are not sure what will happen, you can place a bottle with the fuel in your freezer and see what happens.

### **PARTS SUSCEPTIBLE TO COLD**

The quick connect and O-rings are the stove parts most susceptible to cold. The O-rings may stiffen and crack when the temperature falls below -20 °C (-4 °F). Check them before leaving on your trip, and replace them if they look worn.

### **EFFICIENT FOOD PREPARATION**

When the weather is cold, it is of course even more important to use a wind screen and a lid on your pan when cooking: this considerably reduces the amount of time/fuel needed to heat your food. With our Optimus Terra set of cooking pans, you can also keep your food hot once it has been taken off the stove.

### **OPTIMUS NOVA ON SNOW**

When you use your Optimus Nova on snow, it is important that you place a non-flammable base beneath the stove so that it will not sink into the snow while you cook. Set up a surface on which you can place the stove, bottle and pans, and pack the snow down hard so as to form a firm base.

### **MELTING SNOW**

You can melt snow more quickly if you start with a little water in the bottom of the pan. It takes longer to melt ice than it does to melt snow.

### **WASHING DISHES IN WINTER**

Washing up pans is always a little more complicated in winter. Use Teflon coated pans and leave the leftover food to freeze before scraping it out with snow. You can also dissolve grease in the pans using cooking oil and then wiping it out. It is a good idea to boil water for dishwashing right after cooking in order to save fuel.

### **OPTIMUS NOVA AT ALTITUDE (MORE THAN 4,000 METERS)**

The Optimus Nova is one of the best stoves on the market for use in extreme situations. Among other things, this stove has been used successfully in the Himalayas at altitudes of 7,400 meters. However, using multifuel stoves with liquid fuels at altitudes in excess of 4,000 meters can cause problems. Burning may be uneven due to the fact that there is less oxygen in the atmosphere. Choose your fuel carefully and make sure that there is free access to air around the stove. Gasoline and white gasoline is sometimes difficult to use at high altitude since it evaporates easily already in its liquid form. Normally good quality kerosene performs well at high altitude.

Visit [www.optimusstoves.com](http://www.optimusstoves.com) for more useful tips.

### FUEL IS LEAKING OUT

- **Between the bottle and the pump**  
Check that the pump is screwed on securely.  
Check the rubber gasket, and replace it if it is damaged.
- **At the quick connect**  
Check the O-ring on the tip of the fuel hose and replace it if it is damaged, worn or missing.
- **At the control valve**  
Unscrew the control and check the O-rings. Replace these if they are damaged.
- **Between the fuel hose and the control valve**  
Dismantle, clean and reassemble.
- **From the hole where the pump rod enters the pump**  
The pump's drain valve is leaking and has to be replaced. This is also evident by the pump rod slowly coming out of the pump pipe.

### THE FLAME IS YELLOW AND FLARING

- **Insufficient preheating**  
Repeat the entire preheating process, or close the control and wait a while before switching it back on.
- **You have turned the control valve too far**  
Turn the control valve back.
- **Impure fuel**  
Use only petroleum based fuels such as gasoline, kerosene and diesel. Do not mix different types of fuel.
- **Poor oxygen supply**  
Make sure that your stove has free access to air.
- **The nozzle is loose**  
Leave the stove to cool, then screw the nozzle into position.

### THE STOVE IS NOT VERY HOT

- **Bottle pressure too low**  
Pump a few times in order to increase the pressure in the bottle. If this does not help, check whether the pump leather is dry or damaged. Soften it with your fingers, and lubricate it with oil or replace it if so required. Check also that the pump is screwed together properly.
- **Nozzle blocked**  
Clear the nozzle by moving the multitool magnets beneath the burner. If this does not help, you will have to remove the nozzle and push the cleaning needle through the nozzle hole from the inside.
- **Fuel filter clogged**  
If output increases when the fuel bottle is turned to the off position, then the fuel filter is clogged. Replace the fuel filter. See Advanced maintenance for details.
- **Fuel grooves on the spindle blocked**  
Unscrew the spindle and clean the grooves.



## EN - MAINTENANCE – ROUTINE MEASURES

### **CLEARING THE NOZZLE**

You should clear the nozzle in the burner every time you use the stove. This is done by moving the multitool magnets back and forth a few times beneath the burner's base nut. The patented Optimus cleaning needle will then be activated. If you operate the cleaning needle while the stove is burning, the flame may go out. Keep a match or lighter at hand when operating the cleaning needle and relight the stove if necessary.

### **CHECKING THE O-RINGS**

It is important to ensure that the spindle's O-rings are complete and undamaged in order to avoid fuel leakage. Get into the habit of occasionally checking the two O-rings by unscrewing the control valve and spindle. Replace the O-rings if you suspect that they are cracked or otherwise damaged.

The tip of the fuel hose has an o-ring which may benefit from lubrication so they function satisfactorily in cold climates. Use Optimus lubricant or another oil which can withstand harsh cold.

If you are out in winter, you must pay particular attention to all rubber O-rings and seals. These may become hard and brittle in severe cold, and possibly crack. To be on the safe side, replace the old ones and take a few spares with you if you are going to be out for a long time, a long way from civilization.

### **LUBRICATING THE PUMP LEATHER**

You should lubricate the pump leather using Optimus lubricant so the pump will function perfectly. It is particularly important to check this if the stove has not been used for a long time. The pump leather is located at the far end of the pump rod. This is accessed by unscrewing the pump rod and pulling out the pump rod entirely from the pipe. Lubricate the leather using a small amount of lubricant (butter can be used in an emergency). Be careful when replacing the pump rod.

## MORE ADVANCED MAINTENANCE AND SERVICE - EN

### CLEANING THE NOZZLE AND CLEANING NEEDLE

If the stove is not functioning satisfactorily and the routine measures above do not help, the nozzle and cleaning needle may need to be cleaned. Remove the burner plate, use the tip of the multitool as a screwdriver and unscrew the nozzle. Remove the cleaning needle from the burner. Wipe clean the cleaning needle body and the inside of the nozzle. Clean the nozzle hole by carefully pushing the cleaning needle through the nozzle.

### CLEANING THE SPINDLE'S FUEL GROOVES

If the stove is still not getting very hot even though you have cleaned the nozzle and cleaning needle, the spindle's fuel grooves may need to be cleaned. Unscrew the control valve (+) as far as it will go. Use the multitool to unscrew the spindle nut. Unscrew the control valve fully and then pull it out together with the spindle. Clean carefully the two grooves running longitudinally, with the spindle on the tip, using a fingernail, for example. Take care not to damage the spindle threads.

### REPLACING THE FUEL FILTER

If you are still having problems with the stove, the fuel filter may need to be replaced. The fuel filter is located at the end of the plastic tube on the fuel pump. Unscrew the patterned part of the filter holder and push the filter out using a pointed object. Make sure the filter holder is clean before inserting the new filter. If you have problems with the fuel filter, you can use the stove without one for a brief period. It will be more sooty than usual. Some fuels also tend to flare more if no filter is fitted. Replace the filter when you get home.

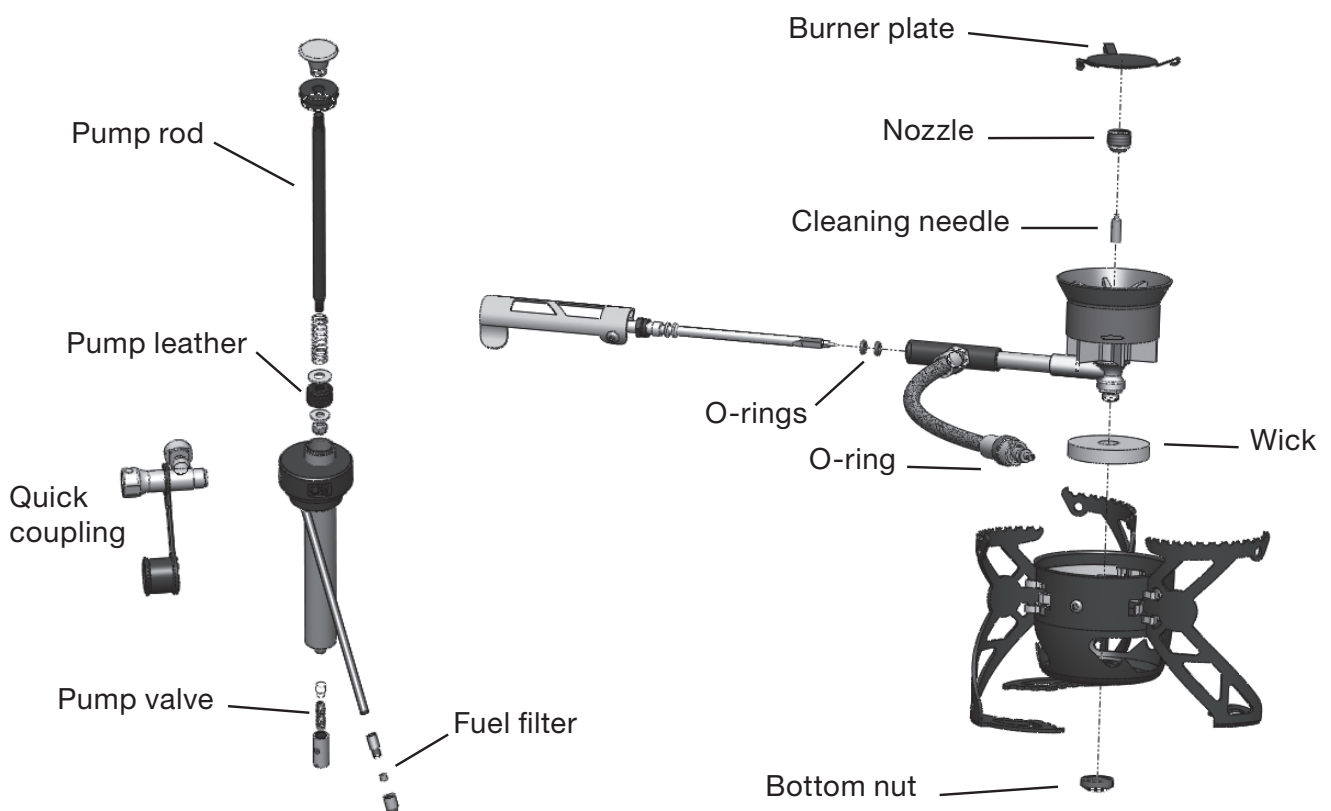

## EN - SPARE PARTS

For simple maintenance of your Optimus Nova stove, the following spare parts are included with the purchase:

1 ea Optimus lubricant ITEM NO. 8018276

1 ea Fuel filter ITEM NO. 8017456

2 ea O-rings ITEM NO. 8017877, 8017455 (2x)

We recommend that you perform regular maintenance in order to enhance the life and reliability of the stove. For this purpose, Optimus provides a **Regular Maintenance Kit ITEM NO. 8016305**.

If you are going off on longer trips, we recommend that you take along **Extensive Repair Kit ITEM NO. 8017632** for your Optimus Nova stove. This will allow you to perform advanced maintenance measures in the field.

### WARRANTY

Optimus provides a 2-year warranty against manufacturing defects. Proof of purchase showing the date the product was purchased and where is required for this warranty to be valid. The warranty is valid for the original purchaser only. This warranty does not cover damage due to accident, improper use or modifications carried out by the user. This warranty gives you specific legal rights and you may have other legal rights which vary from state to state.

If you have any problems with your Optimus Nova, return it to your dealer or contact Optimus. Clear food and dirt from the stove before handing it over.

For more information, contact your dealer or Optimus by e-mail: [outdoor@optimus.se](mailto:outdoor@optimus.se).

### SERVICE FUNCTIONS OF THE MAGIC™ MULTITOOL

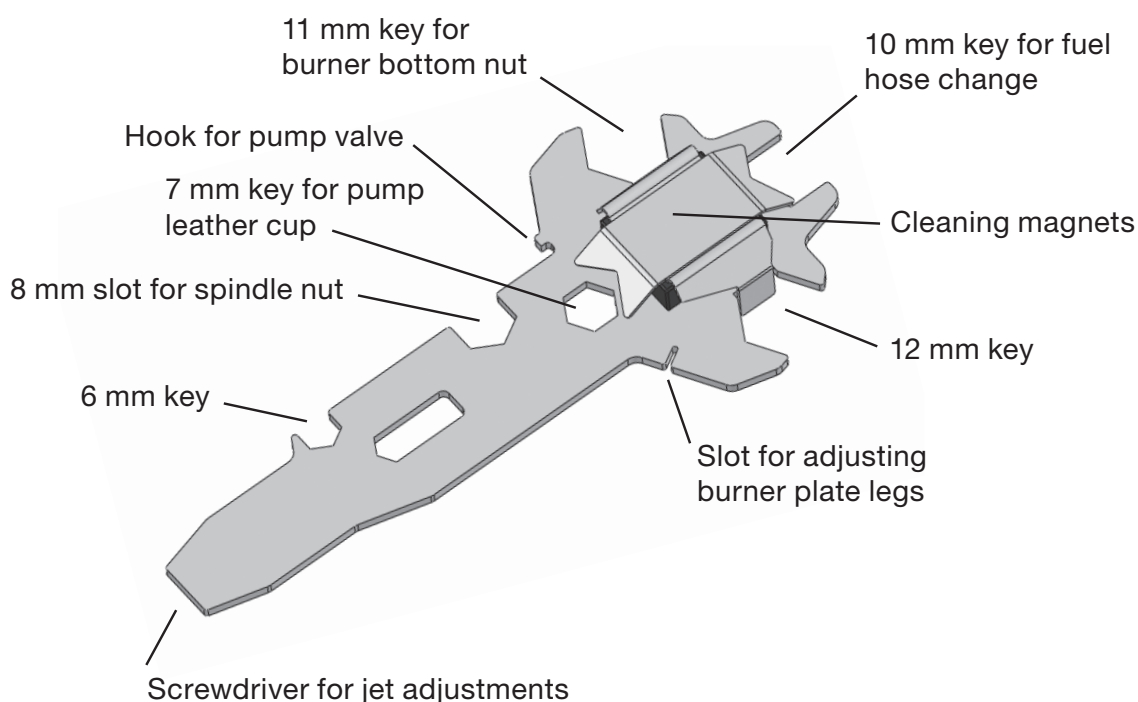





[www.optimusstoves.com](http://www.optimusstoves.com)